

# Light Intensity Switches Ex9LAS and Ex9LDS2



- Rated operating voltage 230 V AC
- Analogue and digital version
- Without and with integrated time switch
- Random switching mode (Ex9LDS2)
- Adjustable light sensitivity up to 50 000 lx
- External brightness sensor with IP65 rating

Light Intensity Switches Ex9LAS and Ex9LDS2 are used for light switching according to actual daylight intensity (Ex9LDS2 device also according to time), so the light fixtures are switched only if necessary and it can save money for consumed energy.

This switch can automatically change between summer and wintertime. It operates in daily, weekly or yearly switching program and can be connect to light control systems with other devices.

External brightness sensor is included in the scope of delivery.

## Type Key

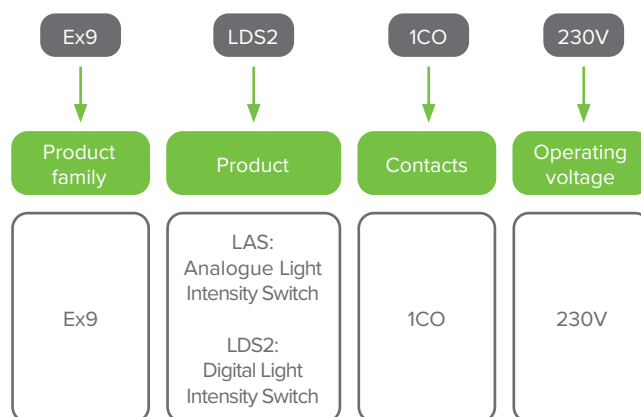

## Certification marks



# Light Intensity Switches **Ex9LAS** and **Ex9LDS2**

## Analogue version

- Two light adjustment ranges LUX1 (1 - 100 lx) and LUX2 (100 - 50 000 lx), TEST for permanent change of contact
- Adjustable time delay (0 - 2 min) to eliminate short term fluctuation in illumination
- LED indication on front of the device
- Surface-mounted brightness sensor in the scope of delivery



Channels	Width	Article No.	Type	Packing
1	1MU	110560	Ex9LAS 1CO 230V	1

## Digital version

- Combination of time switch and light intensity switch - time switch is superior
- Daily, weekly and yearly program of integrated time switch
- Light adjustment range 10 - 50 000 lx
- Random switching function
- Sealable transparent cover of front panel
- Surface-mounted brightness sensor in the scope of delivery



Channels	Width	Article No.	Type	Packing
1	2MU	116938	Ex9LDS2 1CO 230V	1

## Spare light intensity sensor for digital version **Ex9LDS2**

- Spare light intensity sensor for digital light intensity switch Ex9LDS2
- Not compatible with first generation Ex9LDS and analogue series Ex9LAS



Description	Article No.	Type	Packing
1	116938	Ex9LDS2 1CO 230V	1

# Technical Data **Ex9LAS**

## Modular Light Intensity Analog Switches

### General parameters

For light switching according to actual light intensity
Two light adjustment ranges LUX1 (1 - 100 lx) and LUX2 (100 - 50 000 lx), TEST for permanent change of contact
Adjustable time delay (0 - 2 min) to eliminate short term fluctuation in illumination
LED indication on front of the device
Brightness sensor for surface-mounting in the scope of delivery

### Electrical parameters

Tested according to	EN 60669-1, EN 60669-2-1
Rated operating voltage $U_e$	230 V AC
Operating voltage tolerance	200 — 253 V AC
Rated frequency $f$	50/60 Hz
Rated current $I_e$	
AC-1, $\cos \phi$ 1	16 A
Power input (apparent / loss)	max. 3 VA / 1.6 W
Power consumption	$\leq$ 4 W
Channels	1
Switch contact	CO (change-over)
Switching capacity (AC1 / DC)	4000 VA / 384 W
Switching voltage (AC1 / DC)	250 V / 24 V
Inrush current	30 A / $<$ 3 s
Dielectric strength (supply - output)	4 kV
Light adjustment range (LUX1 / LUX2)	1 — 100 lx / 100 — 50000 lx
Switching delay	0 — 2 min
Switching delay setting	potentiometer
Maximum length of connecting cables for sensor	50 m
Brightness sensor	external (in the scope of delivery)
Electrical life (AC1)	100 000 operation cycles
Control power input	0.8 — 530 mVA
Load between S-A2	possible
Impulse length	min. 25 ms
Reset time	150 ms

# Technical Data **Ex9LAS**

## Modular Light Intensity Analog Switches

### Mechanical parameters

Device width	17.6 mm
Device height	90 mm
Frame size	45 mm
Mounting	onto 35 mm device rail (DIN)
Mounting position	any
Degree of protection	
device	IP40 from front panel / IP20 terminals
brightness sensor	IP65
Terminals	screw terminals
Terminal capacity	
device	1 – 2.5 mm <sup>2</sup>
brightness sensor	0.35 – 2.5 mm <sup>2</sup>
Fastening torque of terminals	1.2 Nm
Mechanical life	10 000 000 operation cycles
Ambient temperature	
device	-20°C – +55°C
brightness sensor	-20°C – +55°C
Installation class	II
Pollution degree	2
Overvoltage category	III
Weight	
device	0.063 kg
brightness sensor	0.02 kg

### Dimensions

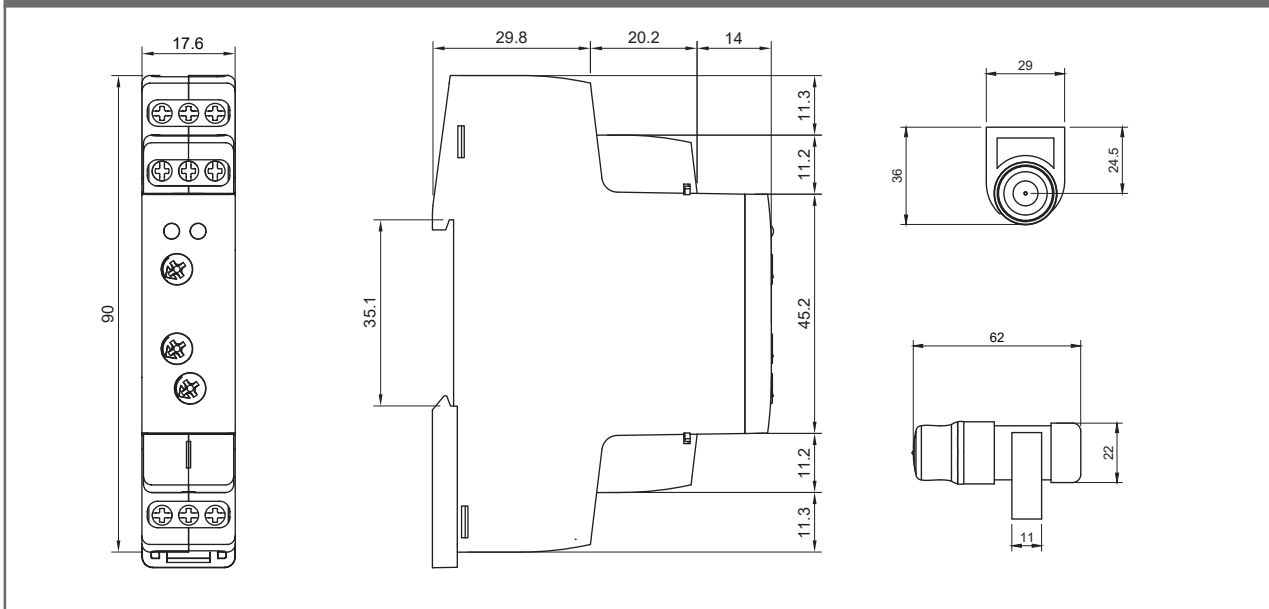

# Technical Data **Ex9LAS**

## Modular Light Intensity Analog Switches

### Wiring diagrams

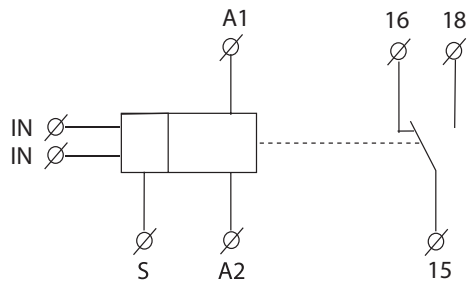

### Connections

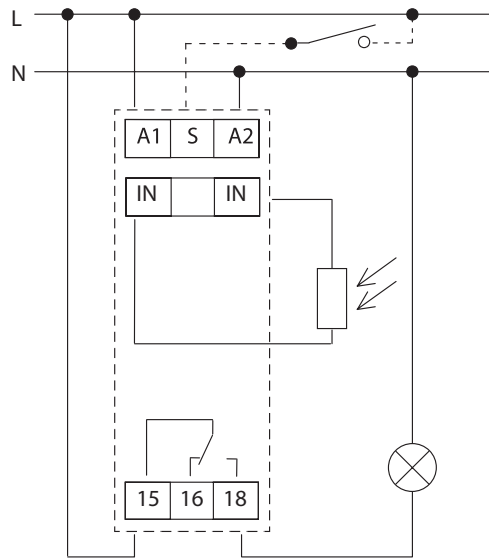

# Technical Data **Ex9LDS2**

## Modular Light Intensity Digital Switches

### General parameters

Switching according to a program (AUTO) / permanently manual / random
Modular design
External sensor IP65 issuitable for mounting on the wall or in panel
Automatic summer/winter time change
Random switching function for simulation of presence in a house when nobody is at home
Time clock can override the light sensor for applications when lights are not required
Sealable front cover

### Electrical parameters

Tested according to	EN 61812-1, EN 60669-1, EN 60669-2-1
Rated operating voltage $U_e$	230 V AC
Operating voltage tolerance	200 — 253 V AC
Rated frequency f	50/60 Hz
Rated current $I_e$	
AC-1, $\cos \varphi 1$	8 A
Power consumption	1.7 W
Channels	1
Switch contacts	CO (change-over)
Switching voltage (AC / DC)	250 V AC1 / 30 V DC
Switching power (AC1 / DC)	2000 VA / 240 W
Dielectric strength (supply - output)	4 kV (supply-output) / 3.5 kV (supply-sensor)
Display type	LCD with backlight
Back-up supply	yes, CR2032 (3V)
Data stored for	min. 10 years
Photoelectric switch	
adjustment range	10 — 50 000 lx
Time switch	
memory	100 spaces
shortest switching time	1 min.
programmable	every 1 min.
block formation	daily, weekly, yearly
switching state display	yes
summer/winter time	automatic change
functions	automatic / manual / random
accuracy	$\pm 1$ sec. / day at +23°C
running reserve	3 years
Brightness sensor	external (in the scope of delivery)
Electrical life (AC1)	100 000 operation cycles

# Technical Data Ex9LDS2

## Modular Light Intensity Digital Switches

### Mechanical parameters

Device width	35 mm
Device height	90 mm
Frame size	45 mm
Mounting	onto 35 mm device rail (DIN)
Mounting position	any
Degree of protection	
device	IP40 from front panel / IP20 terminals
brightness sensor	IP65
Terminals	screw terminals
Terminal capacity	
device	1 – 2.5 mm <sup>2</sup>
brightness sensor	min. 0.35 mm <sup>2</sup>
Fastening torque of terminals	1.2 Nm
Mechanical life	30 000 000 operation cycles
Ambient temperature	
device	-10°C – +55°C
brightness sensor	-20°C – +55°C
Installation class	III
Pollution degree	2
Overvoltage category	III
Weight	
device	0.142 kg
brightness sensor	0.016 kg

### Dimensions

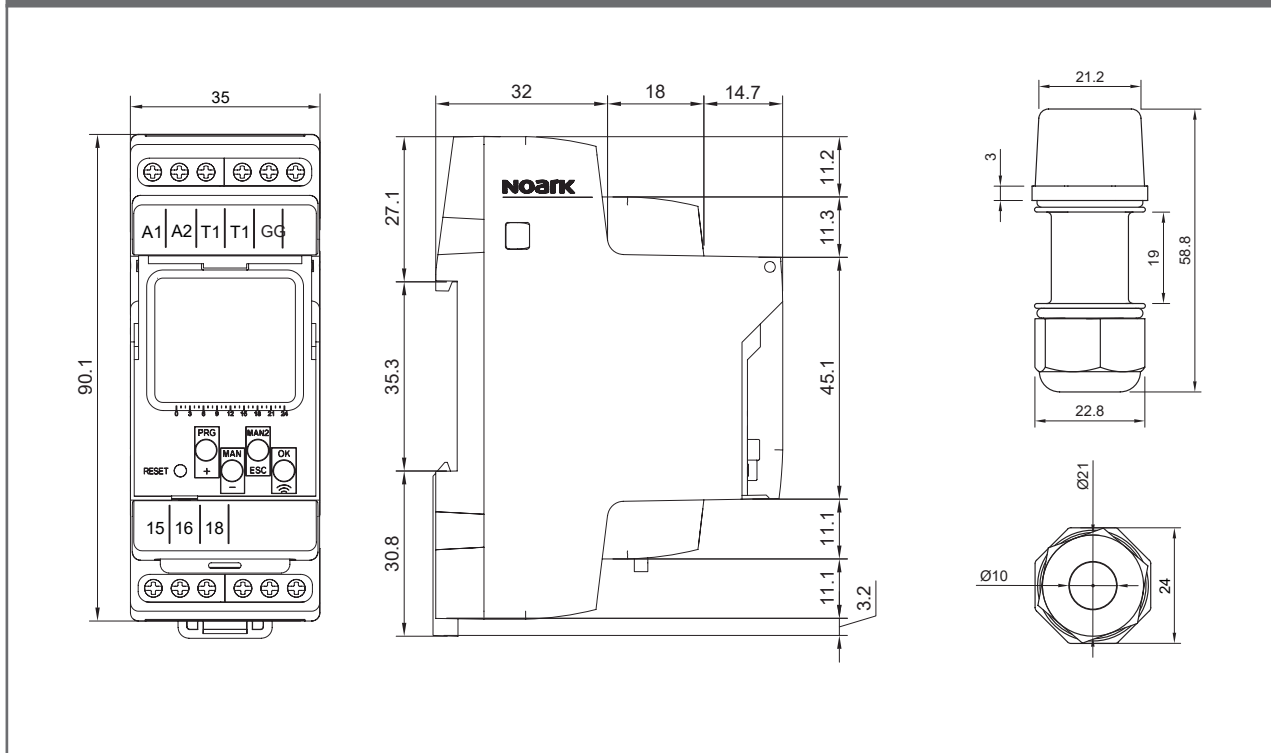

# Technical Data Ex9LDS2

## Modular Light Intensity Digital Switches

### Wiring diagram

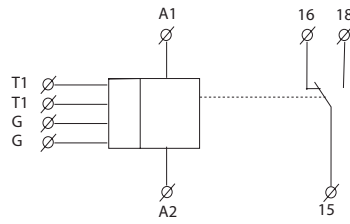

### Connections

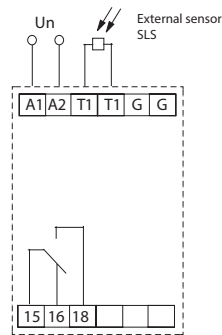

### Description

